

DIMENSION DRAWINGS

PLLW362 PLLW350 PLLW340 PLLW330

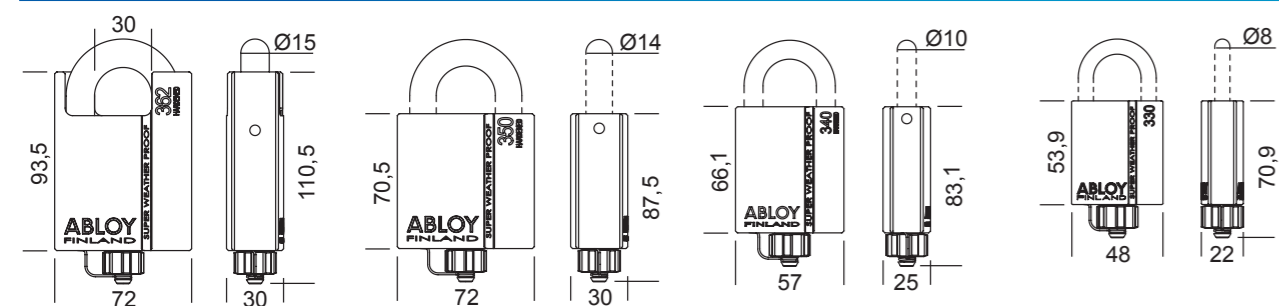

PLM350 PLM340 PLM330

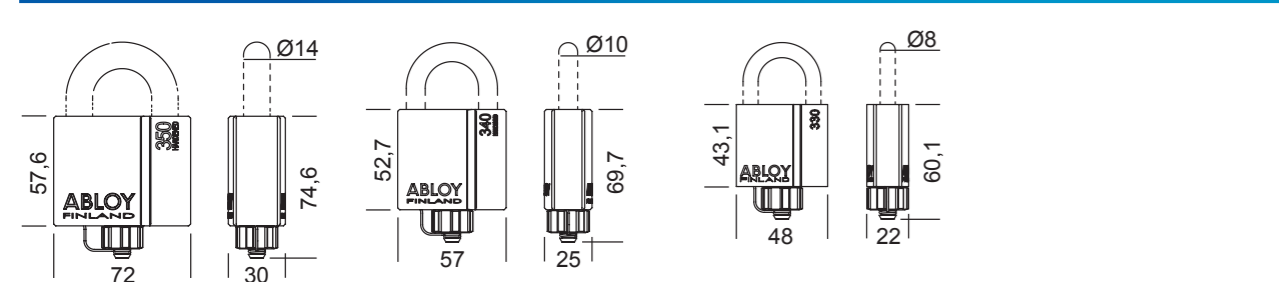

PL362 PL358 PL350 PLI350 PL342

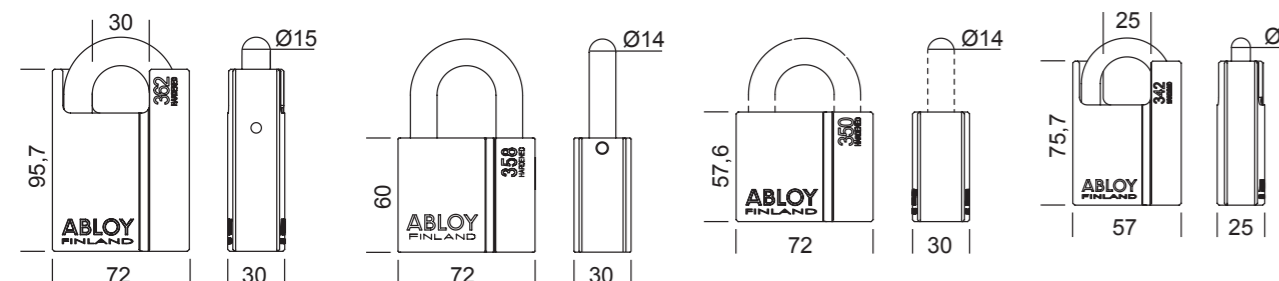

PL341 PL340 PLI340 PL330(C,N,B) PL330(T,U) PLI330

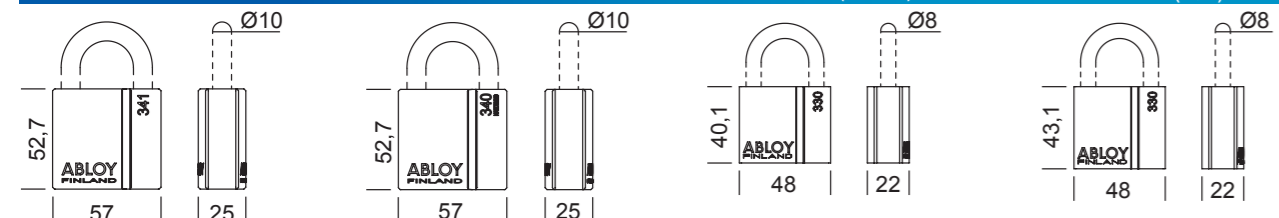

PL321 PL320 3020 3021 PL318

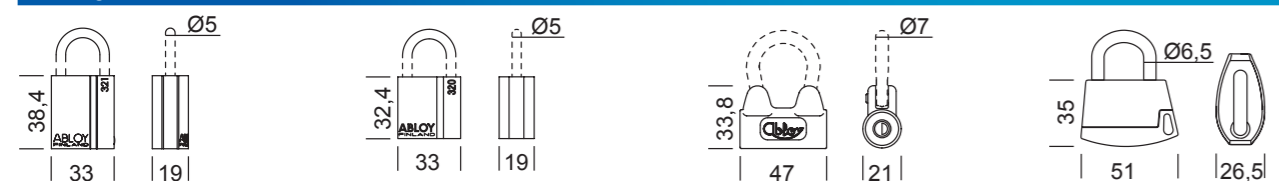

STABLE



PL200, PL202

- 12 mm shackle hole
- Grade 3
- PL200 for right-handed doors
- PL202 for left-handed doors
- For frame fixing
- Zinc-plated, polyester-coated case-hardened steel
- Fixing screws included

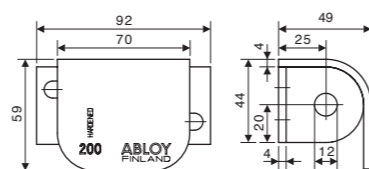

PL201, PL203

- 18 mm shackle hole
- Grade 4
- PL201 for right-handed doors
- PL203 for left-handed doors
- For frame fixing
- Zinc-plated, polyester-coated case-hardened steel
- Fixing screws included

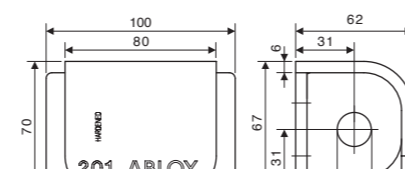

PL204

- 12 mm shackle hole
- Non-handed
- For frame fixing
- Zinc-plated, polyester-coated case-hardened steel
- Fixing screws included

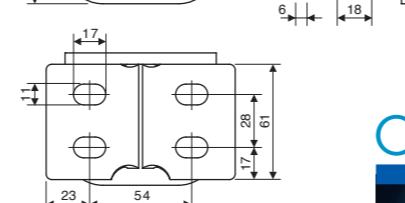
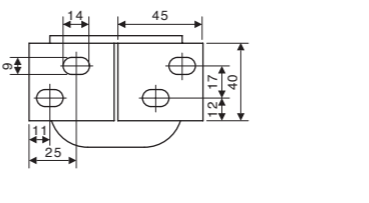
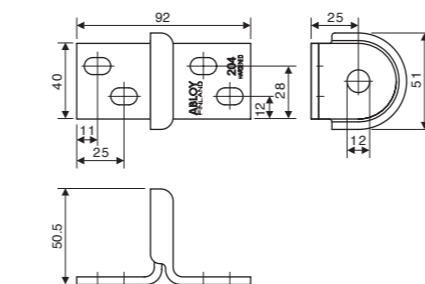

CHAINS



Attachment chain (length 220 mm) makes it easier to ensure that a padlock does not get mislaid while the object that it secures is open. These chains must not be used as part of a security installation.

Chains are available in two sizes, 805349 for a 8 mm shackle and 805351 for a 10 mm shackle. 810270 for a 14 mm shackle.

COVERS

Different plastic covers are available to provide additional protection against dust and impact. 808248 to suit PL330 805649 to suit PL340, PL341 and PL342.



DO-IT-YOURSELF PACKS

The following models of padlock are available in Do-it-Yourself packs: PL350, PL350/5 | PL342 | PL341, PL341/50 | PL340, PL340/50 | PL330, PL330/50 | PL320, PL320/50, 3 x PL320 | 3020, 3021 | 3022 (2 x 3020) | PL200, PL202, PL204



www.abloy.com

Abloy Oy
Wahlforssinkatu 20
P.O.Box 108
FI-80101 JOENSUU
FINLAND
Tel. +358 20 599 2501
Fax +358 20 599 2209



8801401 06/2012 2000 kpl PunaMusta Oy, Joensuu



ABLOY® PADLOCKS

Technical brochure

ABLOY® padlocks offer a selection of different key systems, key profiles and key security levels.



SECURITY IS THE KEY TO SUCCESS

Everyone needs to be secure.

Governments, companies, organizations and private individuals.

Criminal acts, violence and breakdowns in information transfer, production and distribution occur increasingly often in everyday life - good reason to ensure that there are no gaps in your security. Everyone can then concentrate on what is most important to them. Without having to worry.



PROVEN DURABILITY

ABLOY® padlocks have been designed and manufactured to not only meet the requirements of the EN12320 padlock standard, but exceed as the requirements of our own tests are significantly higher.

ABLOY® padlocks continued to operate smoothly throughout exhaustive durability tests such as the acetic acid salt-spray test – they are therefore the best possible alternative

for use in unprotected locations where the environmental conditions are severe. Abloy Oy has paid particular attention in design of environmentally friendly production methods. As a result we use the most modern and environmentally friendly surface plating facility in Finland.

All the operations are qualified with the ISO9001 and ISO14001 certifications.

SECURITY GRADES ACCORDING TO THE EN12320 PADLOCK STANDARD

Requirements	1	2	3	4	5	6	
Minimum number of differs	300	1 000	2 500	5 000	10 000	20 000	
Pulling of shackle/staple	3	5	15	30	70	100	kN
Twisting of shackle/staple	40	100	200	450	1 200	2 500	Nm
Cutting of shackle/staple	6	15	25	35	70	100	kN
Blow on shackle/staple (weight/g x height/mm) Test temperature			1 250 x 800 -20°C	3 050 x 1 000 -40°C	6 550 x 1 400 -40°C	7 150 x 1 500 -40°C	x5 times
Blow on lock body (weight/g x height/mm) Test temperature			1 250 x 800 -20°C	3 050 x 1 000 -20°C	6 550 x 1 400 -40°C	7 150 x 1 500 -40°C	x5 times
Load on cylinder plug or locking mechanism			4	5	10	15	kN
Drilling				2	4	8	min
Sawing				1	4	8	min
Torque resistance of cylinder plug			5	15	20	30	min

MODEL		BODY		SHACKLE								PROPERTIES				SWP-PROPERTIES			CYLINDER OPTIONS							
Product Code	GRADE	Material	Finish	Material	Finish	Diameter						Number of discs	Rekeyable		Key Removable		Sealed shackle	weather seal cap	IP-class	CLASSIC	SENTRY	NOVEL	PROTEC (N) PROTEC² (T)		CLIQ	
						mm	inches	mm	inches	mm	inches		Yes	No	In locked position	In locked and unlocked position							N	T		T/N
PLLW362	6	CHS	Chrome	CHBS	Chrome	15	19/32	25	63/64	30	1 11/64	9	x		x		x	x	IP 68						x	
PL362	6	CHS	Chrome	CHBS	Chrome	15	19/32	25	63/64	30	1 11/64	11	x	x	x						x					
PLLW350	5	CHS	Chrome	CHBS	Chrome	14	35/64	25	63/64	31	1 7/32	9	x		x		x	x	IP 68						x	
PLLW350/50	5	CHS	Chrome	CHBS	Chrome	14	35/64	50	1 31/32	31	1 7/32	9	x		x		x	x	IP 68						x	
PLM350	5	CHS	Chrome	CHBS	Chrome	14	35/64	25	63/64	31	1 7/32	11	x		x		x	x			x				x	
PLM350/50	5	CHS	Chrome	CHBS	Chrome	14	35/64	50	1 31/32	31	1 7/32	11	x		x		x	x			x				x	
PLI350	5	CHS	Chrome	CHBS	Chrome	14	35/64	25	63/64	31	1 7/32	11	x		x		x	x			x				x	
PLI350/50	5	CHS	Chrome	CHBS	Chrome	14	35/64	50	1 31/32	31	1 7/32	11	x		x		x	x			x				x	
PL350	5	CHS	Chrome	CHBS	Chrome	14	35/64	25	63/64	31	1 7/32	11	x	x	x					x	x				x	
PL350/50	5	CHS	Chrome	CHBS	Chrome	14	35/64	50	1 31/32	31	1 7/32	11	x	x	x					x	x				x	
PL358		CHS	Chrome	CHBS	Chrome	14	35/64	38	1 1/2	31	1 7/32	11	x	x	x						x					
PLLW340	4	CHS	Chrome	CHBS	Chrome	10	25/64	25	63/64	28	1 3/32	9	x		x		x	x	IP 68							x
PLLW340/50	4	CHS	Chrome	CHBS	Chrome	10	25/64	50	1 31/32	28	1 3/32	9	x		x		x	x	IP 68							x
PLM340	4	CHS	Chrome	CHBS	Chrome	10	25/64	25	63/64	28	1 3/32	11	x		x		x	x			x					x
PLM340/50	4	CHS	Chrome	CHBS	Chrome	10	25/64	50	1 31/32	28	1 3/32	11	x		x		x	x			x					x
PLI340	4	CHS	Chrome	CHBS	Chrome	10	25/64	25	63/64	28	1 3/32	11	x		x		x	x			x					x
PLI340/50	4	CHS	Chrome	CHBS	Chrome	10	25/64	50	1 31/32	28	1 3/32	11	x		x		x	x			x					x
PL340	4	CHS	Chrome	CHBS	Chrome	10	25/64	25	63/64	28	1 3/32	11	x	x	x					x	x					x
PL340/50	4	CHS	Chrome	CHBS	Chrome	10	25/64	50	1 31/32	28	1 3/32	11	x	x	x					x	x					x
PL342	4	CHS	Chrome	CHBS	Chrome	10	25/64	25	63/64	28	1 3/32	11	x	x	x					x	x					x
PL341	3	Brass	Chrome	CHBS	Chrome	10	25/64	25	63/64	28	1 3/32	11	x	x	x					x	x					x
PL341/50	3	Brass	Chrome	CHBS	Chrome	10	25/64	50	1 31/32	28	1 3/32	11	x	x	x					x	x					x
PLLW330	3	Brass	Chrome	CHBS	Chrome	8	5/16	25	63/64	25	63/64	9	x		x		x	x	IP 68							x
PLLW330/50	3	Brass	Chrome	CHBS	Chrome	8	5/16	50	1 31/32	25	63/64	9	x		x		x	x	IP 68							x
PLM330	3	Brass	Chrome	CHBS	Chrome	8	5/16	25	63/64	25	63/64	11	x		x		x	x			x					x
PLM330/50	3	Brass	Chrome	CHBS	Chrome	8	5/16	50	1 31/32	25	63/64	11	x		x		x	x			x					x
PLI330	3	Brass	Chrome	CHBS	Chrome	8	5/16	25	63/64	25	63/64	11	x		x		x	x			x					x
PLI330/50	3	Brass	Chrome	CHBS	Chrome	8	5/16	50	1 31/32	25	63/64	11	x		x		x	x			x					x
PL330	3	Brass	Chrome	CHBS	Chrome	8	5/16	25	63/64	25	63/64	11	x	x	x					x	x					x
PL330	*)	Brass	Chrome	Brass/Stainless Steel		8	5/16	25	63/64	25	63/64	11	x	x	x					x	x		x			x
PL330/50	3	Brass	Chrome	CHBS	Chrome	8	5/16	50	1 31/32	25	63/64	11	x	x	x					x	x					x
PL330/50	*)	Brass	Chrome	Brass/Stainless Steel		8	5/16	50	1 31/32	25	63/64	11	x	x	x					x	x					x
PL330/100	*)	Brass	Chrome	CHBS	Chrome	8	5/16	100	3 30/32	25	63/64	11	x	x	x					x	x					x
PL330/100	*)	Brass	Chrome	Brass/Stainless Steel		8	5/16	100	3 30/32	25	63/64	11	x	x	x					x	x					x
PL321	*)	Brass	Chrome	Stainless Steel		5	13/64	20	15/32	18	45/64	11			x					x	x					x
PL321/50	*)	Brass	Chrome	Stainless Steel		5	13/64	50	1 31/32	18	45/64	11			x					x	x					x
PL320	2	Brass	Chrome	Stainless Steel		5	13/64	20	15/32	18	45/64	9			x					x						
PL320/50	*)	Brass	Chrome	Stainless Steel		5	13/64	50	1 31/32	18	45/64	9			x					x						
3020	2	Brass		CHS	Chrome	7	9/32	35	1 3/8	26	1 1/32	11								x						
3021	*)	Brass		CHS	Chrome	7	9/32	76	3	33	1 5/16	11								x						
PL318	*)	Die-casted zinc with plastic cover		Steel	Chrome	6,5	8/32	20	15/32	21	1/2	9								x						
PL318	*)	Die-casted zinc with plastic cover		Steel	Chrome	6,5	8/32	20	15/32	21	1/2	9								x						

VERSION CODE: PL= standard, PLI= shackle sealed, PLM= shackle sealed and weather seal cap, PLLW= IP68 ABLOY® PROTEC² CLIQ

*) = not tested CHS = case-hardened steel CHBS = case-hardened boron steel