

ABLOY® DC330

Non-handed cam action door closer and sliding arm DC194



Product description

Thanks to the cam construction DC330 is extremely light to open. Suitable for external and internal doors. Can be used with ABLOY FD460 series fire door closing systems.

Overview of Advantages

- CE certified with sliding arm
- Adjustable closing force size EN 1-4 with sliding arm according EN 1154
- Back check (BC) as a standard feature
- Operating temperature range: -15°C...+45°C
- Adjustable latching and back check starting angle by grooved spindle
- Easy adjustment of arm height (14 mm)
- Two pressure relief valves to protect against overload
- Maximum door weight 80 kg and door width 1100 mm with sliding arm installation
- Easy to install

Sliding arm DC194

- With protective cover
- Concealed fastening screws

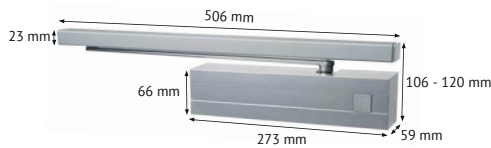

Technical data

Variable adjustable closing force	EN 1-4
Door width up to	1100mm
Fire and smoke protection	Yes
Door swing directions	Left/right handed
Mounting method	Standard and frame installation, hinge and non-hinge side
Closing speed	Variable between 160°-10°
Latching speed	Variable between 10°-0°
Backcheck	Variable above 75°
Opening angle, hinge side	ca. 160°
Opening angle, non-hinge side	ca. 120°
Door closer weight	1.8 kg
Certified in compliance with	1121-CPR-AD5241
CE marking for building products	Yes
Basic colours (door closer, arm)	White (RAL 9016), Silver (EV1), Painted brass, Brown (RAL 8014), Black (RAL 9005), Customised finish
Metal covers	Stainless steel

We reserve the right to make alterations to the products described in this leaflet.

Accessories

Hold-open device DC152



Opening damper DC153



Angle bracket DC113

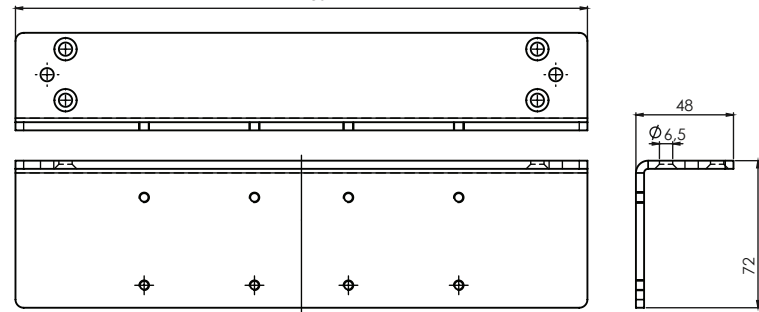

Mounting plate DC130

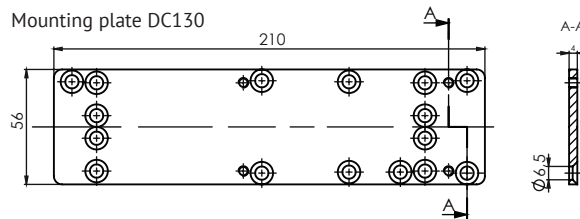

Sliding arm angle mounting plate DC104

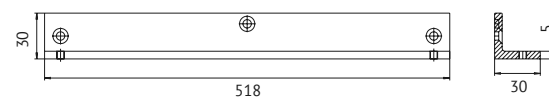

Sliding arm mounting plate DC115

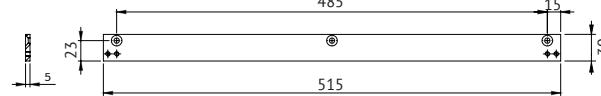

Installation

Hinge side

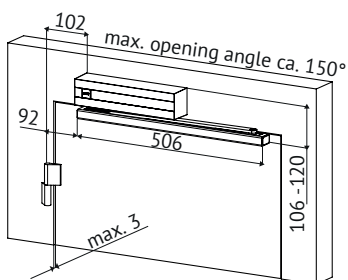
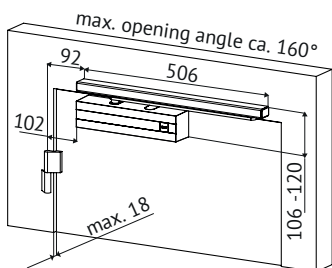

Non-hinge side

